



motoalliance



FIRESTORM
C A B H E A T E R S

Polaris RZR Pro XP Cab Heater
HT_CU_406-ProXP

INSTALLATION INSTRUCTIONS

PARTS LIST

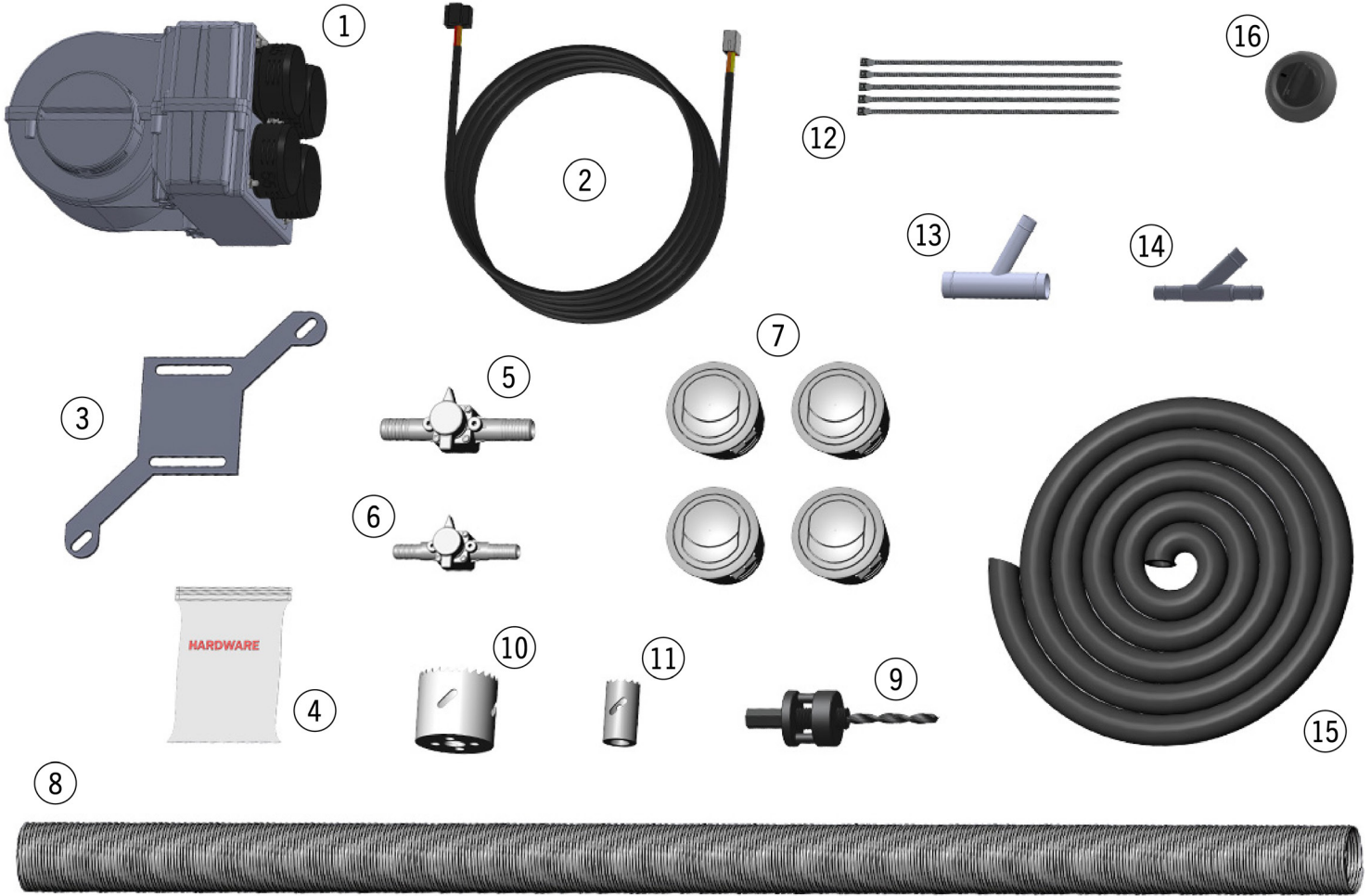

Part#	Qty	Item Description
1	1	FIRESTORM Cab Heater Unit
2	1	36" Wiring Harness
		Orange/Yellow/Black Wire
		Red Wire
		Black Wire
		5-Pin Black Connector
		4-Pin White Connector
3	1	HT_CU_406-ProXP Heater Bracket
4	1	Hardware Pack
	2	Installation Displacement Crimps

Part#	Qty	Item Description
	2	M6-1.0x18mm Hex Head Bolts
	2	¼"x1" Flange Bolts
	2	¼" Flat Washers
	2	¼" Nylock Nuts
	10	#10 Stainless Steel Hose Clamps
	2	#16 Stainless Steel Hose Clamps
	2	Rubber Grommets
5	1	Plastic Shutoff Valve
6	1	½" Plastic Shutoff Valve
7	4	50mm Vents

Part#	Qty	Item Description
8	40"	2" Compressed Duct Hose
9	1	Hole Saw Pilot Bit
10	1	2½" Hole Saw
11	1	1¼" Hole Saw
12	20	Zip Ties
13	1	1" Aluminum Y
14	1	½" Aluminum Y
15	20'	⅝" Radiator Hose
16	1	3-Position Switch



Please read all instructions before beginning installation. Verify that all parts listed are present.

We have found that several steps in this installation are easier with two people. We recommend finding a partner to assist with this installation.



When working on cooling systems, always allow vehicles to cool to avoid being burned or scalded by hot coolant.

Before working with any electrical system on your vehicle, **ALWAYS** remove the negative battery cable and secure it away from the battery terminal.

Figures Color Key

 Parts native to the machine

 Parts native to FIRESTORM Cab Heater

PREPARATION

1. Remove the center panel on the hood of the machine.
2. Remove the dash panel.
3. Remove the two glove compartments from the dash.
4. Remove the skid plate.

HEATER PREPARATION

5. Place the heater unit into the passenger side of the dash with the vents pointing toward the driver side of the machine. **FIGURE 1**

Heater unit
placement in dash

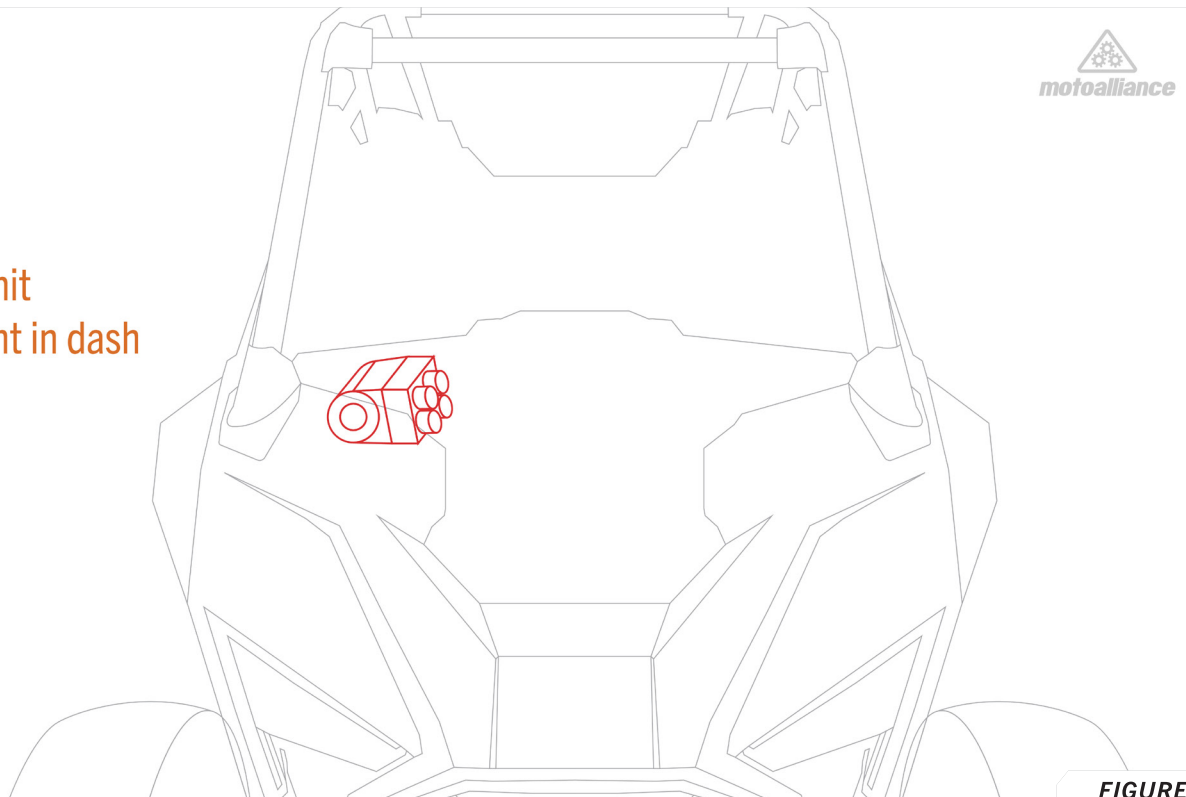
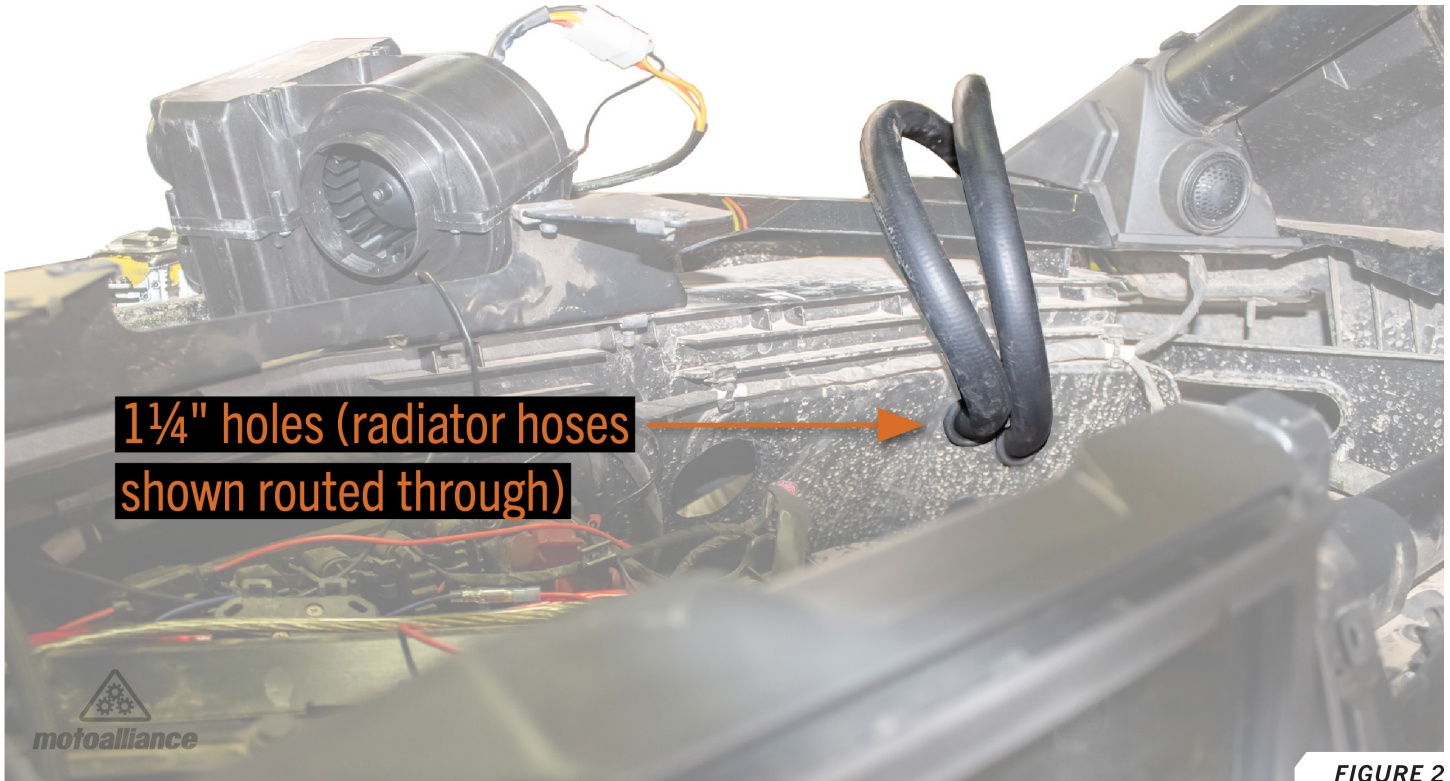
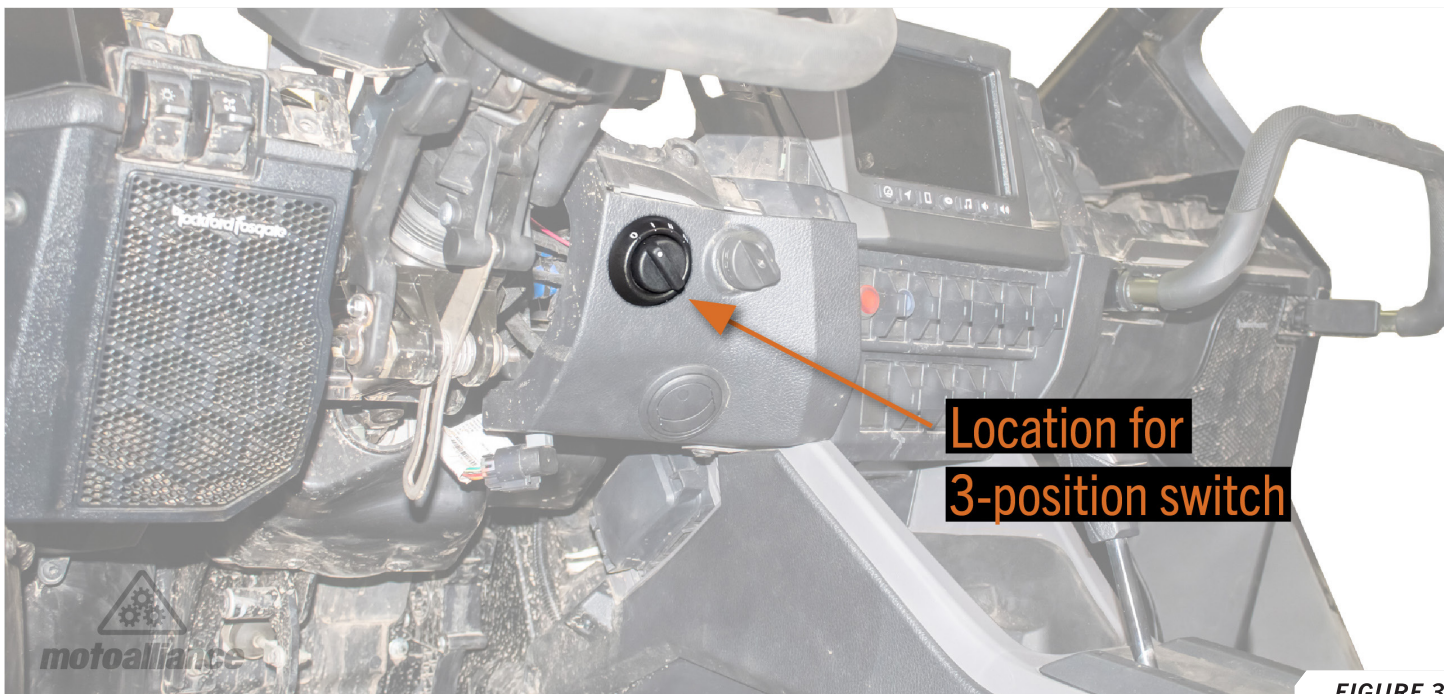

FIGURE 1

6. Use the 1¼" hole saw to drill two holes out of the dash cavity into the front of the machine. **FIGURE 2**



7. Clean any burrs and insert a rubber grommet in each.
8. Locate a spot next to the right of the steering column to place the 3 position switch. **FIGURE 3**



9. Mark the center of the 3 position switch, then drill the hole with a 7/16" drill bit.

RADIATOR HOSE ROUTING

10. Cut a 12' section of radiator hose.
11. Run radiator hose into the dash cavity and connect to the top of the heater unit. *FIGURE 4*
12. Run the 8' section into the dash cavity and connect to the bottom of the heater unit. *FIGURE 4*

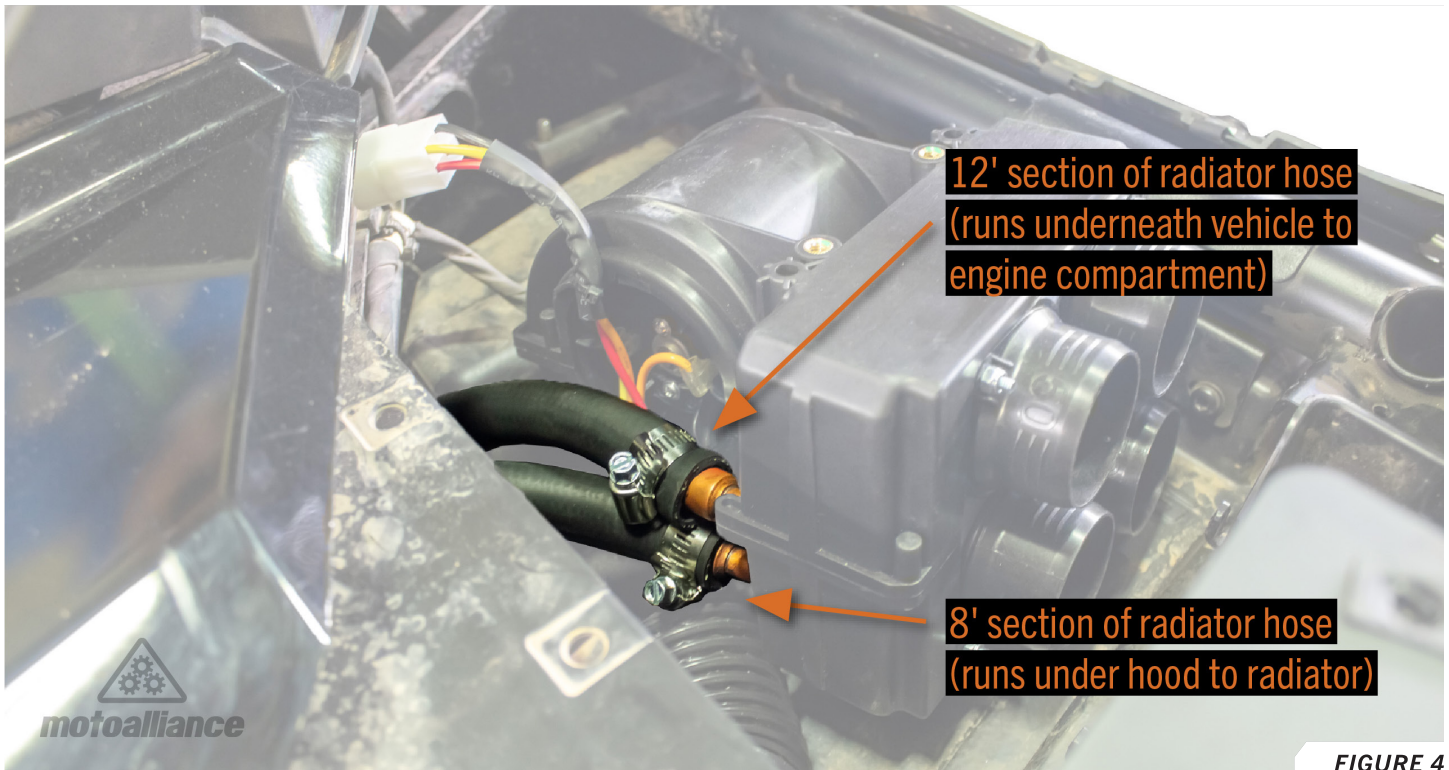
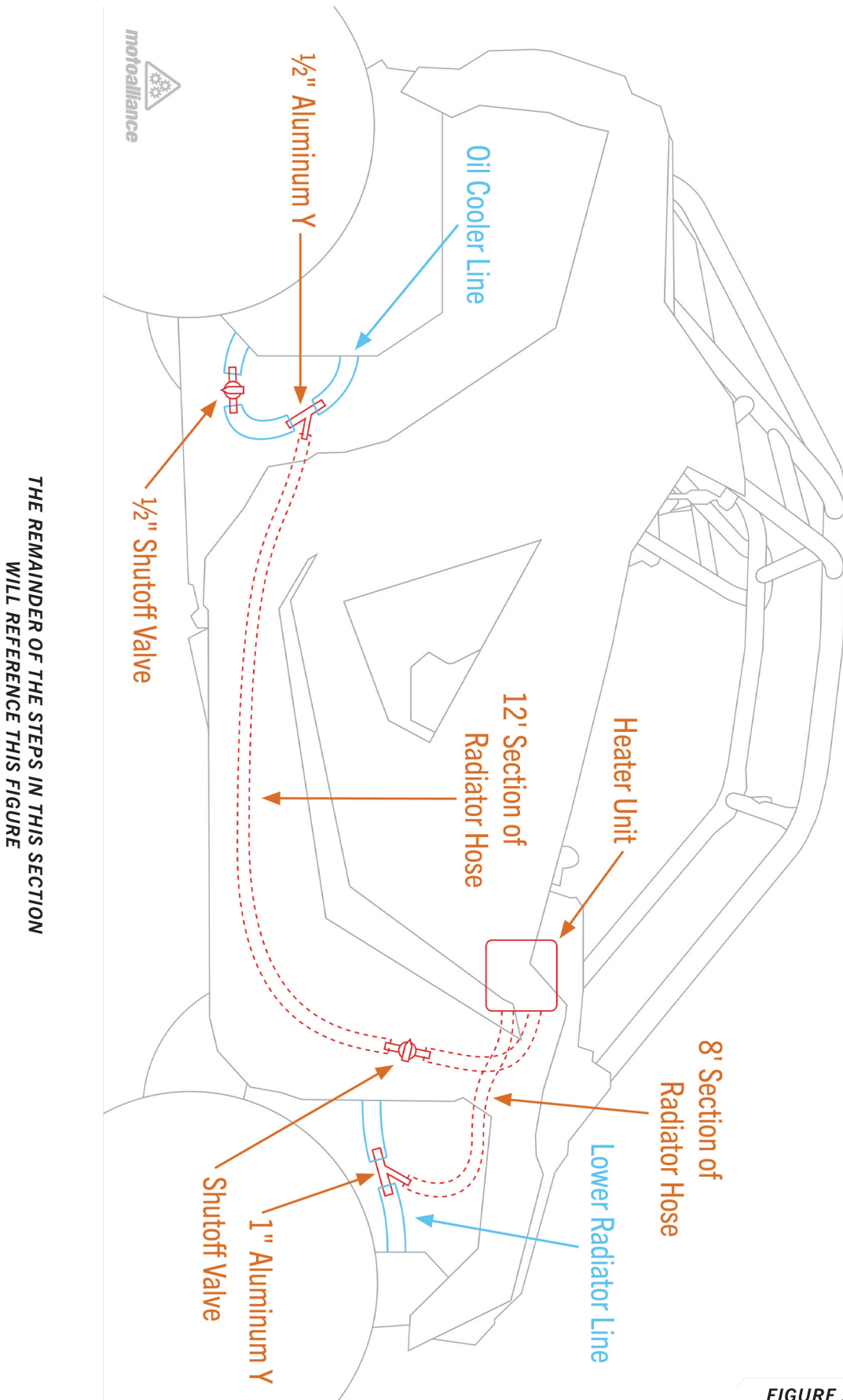

FIGURE 4

13. Secure both radiator hoses with a #10 hose clamp.



THE REMAINDER OF THE STEPS IN THIS SECTION
WILL REFERENCE THIS FIGURE

FIGURE 5

**THE REMAINDER OF THE STEPS IN THIS SECTION
WILL REFERENCE THE FIGURE ON THE PREVIOUS PAGE**

14. With the 12' section of radiator hose, follow the machine's factory radiator hoses under the machine, along the drive shaft cavity.
15. Run the radiator hose up into the engine compartment.
16. Locate the oil cooler line in the back passenger side of your machine.
17. Cut the oil cooler line and insert the ½" aluminum Y with the branch facing the passenger rear wheel well. Secure the oil cooler line with the #10 hose clamps.
18. Run the 12' radiator hose to the branch of the aluminum Y and cut any excess hose. Secure using a #10 hose clamp.
19. Use zip ties to secure the hose.
20. Run the 8' radiator hose to the machine's lower radiator line.
21. Cut the radiator hose and insert the 1" Y with the branch facing the front of the machine. Secure using #16 hose clamps.
22. Cut any excess off of the radiator hose running from the heater and connect it to the Y. Secure using #10 hose clamps.
23. Locate an accessible place on the radiator line running from the oil cooler to the heater unit.
24. Cut the radiator hose and insert the shutoff valve. Secure with #10 hose clamps.
25. On the branch side of the oil cooler line, cut the oil cooler line, insert the ½" shutoff valve, and secure using #10 hose clamps.

Use locking pliers to prevent coolant from spilling out of the oil cooler line.

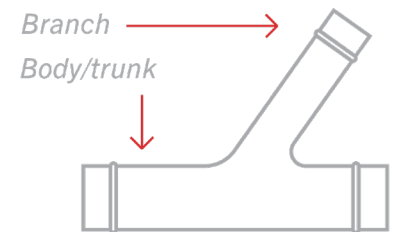

SWITCH WIRING

26. Locate the 36" Wiring Harness and ensure the wires are correctly connected to the 5-Pin Black Connector as shown in *FIGURE 6* and the 4-Pin White Connector as shown in *FIGURE 7*.

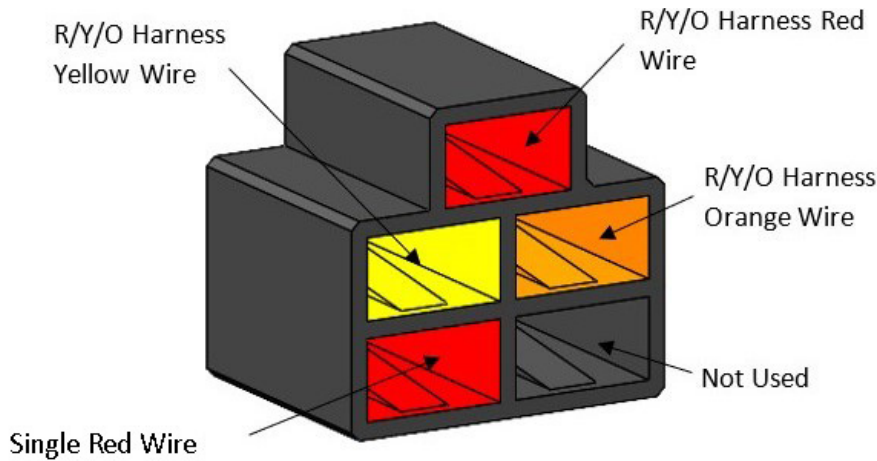

FIGURE 6

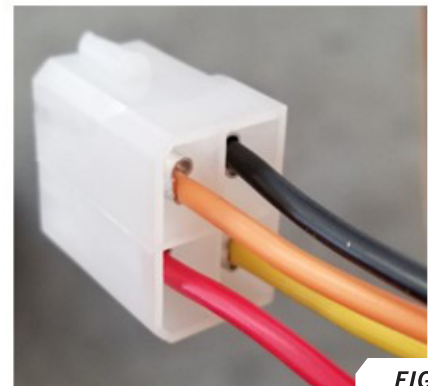
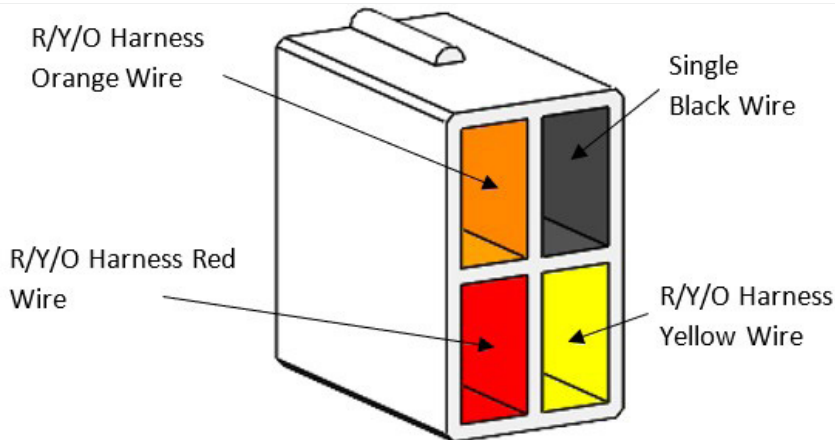

FIGURE 7

27. Connect the 5-Pin Black Connector to the 3-Position Switch included in the kit.
28. Insert the switch from the back of the dash panel, where 7/16" hole was drilled, and secure using the low-profile hex nut included in the switch bag. Disregard the flex lock washer.
29. Prior to pressing the switch bezel on, use a pair of pliers to remove the two nubs on the back of the switch bezel as shown in *FIGURE 8*.

30. Place the bezel over the switch so that the 0, 1, 2, 3 markings are visible.



FIGURE 8

31. Press the switch dial onto the switch until it is seated firmly.
32. Connect the 4-Pin White Connector to the white terminal housing on the heater unit.
33. Connect the red wire to a keyed power source (any power source that is only powered when the vehicle is on) using the terminated end. If you have no connection spot for the terminated end, cut the ring terminal off and use the insulation displacement crimps to connect the red wire to a keyed power source. This can be found by testing wires with a multimeter.
34. Connect the terminated end of the black wire to any vehicle ground.
35. Test the switch to ensure that it can control the fan speed in all three positions.

Common examples may include the ignition, radios, and winches, though this may vary with your vehicle.

DUCT HOSE ROUTING

36. Measure and cut the following lengths of COMPRESSED duct hose:

- 7" (qty 2)
- 6" (qty 1)
- 12" (qty 1)

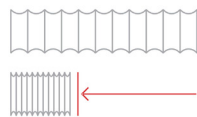

1. Compress

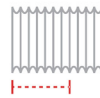

2. Measure

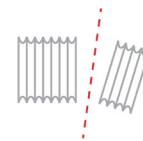

3. Cut

37. Use the 2 $\frac{1}{8}$ " hole saw to cut a hole in the firewall that opens into the wheel well. **FIGURE 9**



FIGURE 9

38. Locate a spot in the passenger foot well above the foot rest. Use the 2½" hose saw to drill out a spot above the foot rest.
39. Clean any burrs and insert the 50mm vent. Secure the 12" duct hose onto the vent using a zip tie. Run the duct hose up into the dash cavity and secure to the bottom left of the heater unit using a zip tie. *FIGURE 10*

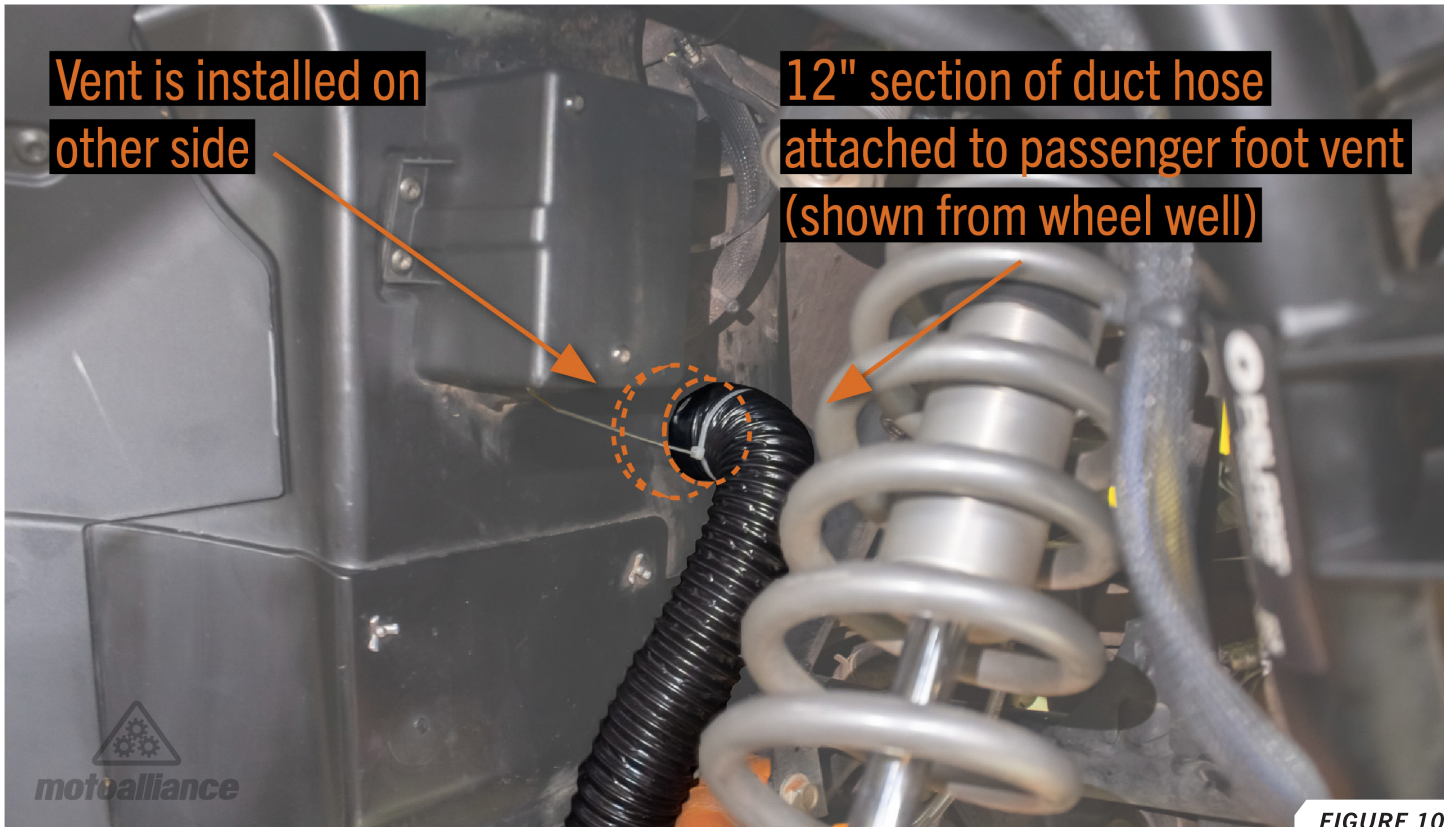

40. Locate the flat surface below the 3 position fan switch. Mark where the center of the vent would be. Take the 2½" hole saw and drill through the panel. **FIGURE 11**
41. Clean any burrs and insert the 50mm vent. **FIGURE 11**



FIGURE 11

42. Connect the 7" duct hose to the 50mm driver vent and secure using a zip tie.
43. Connect the other end of the duct hose to the bottom right side of the heater unit and secure using a zip tie. **FIGURE 12**

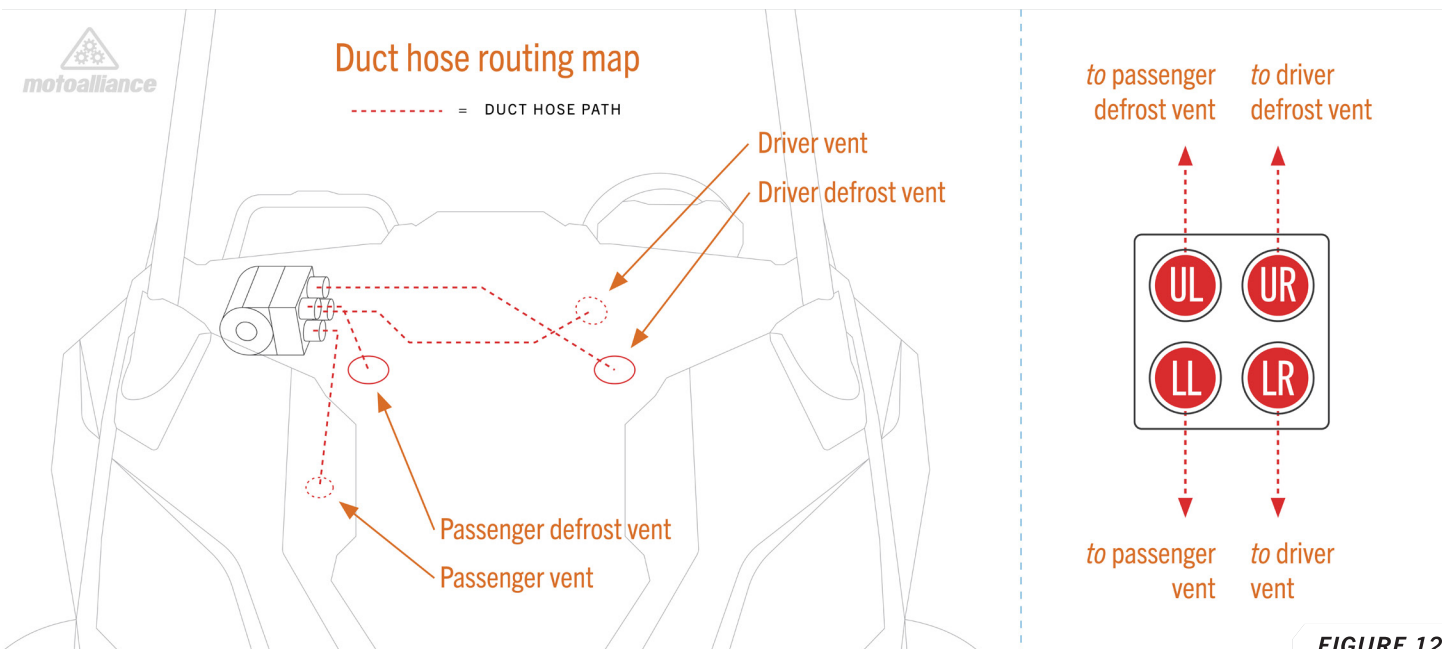
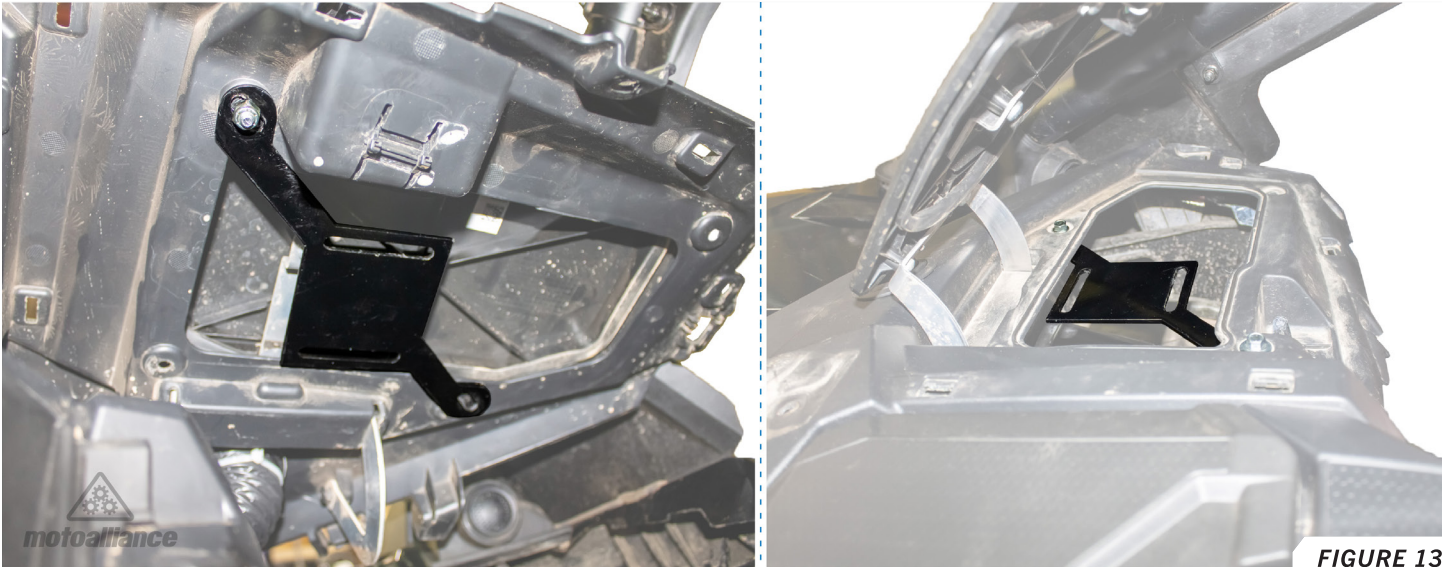

FIGURE 12

HEATER BRACKET

44. Install heater bracket onto the dash in the configuration shown. **FIGURE 13**

It is critical for heater fitment that the bracket orientation is correct.



45. Use the ¼" flange bolts, nylock nuts, and washers to secure the bracket to the dash.

DEFROST DUCT HOSE ROUTING

46. Locate a spot on the dash near the driver side of the windshield. Mark the center location and use the 2½" hole saw to drill a hole in the dash. *FIGURE 14*
47. Locate a spot on the dash near the passenger side of the windshield. Mark the center location and use the 2½" hole saw to drill a hole in the dash. *FIGURE 14*

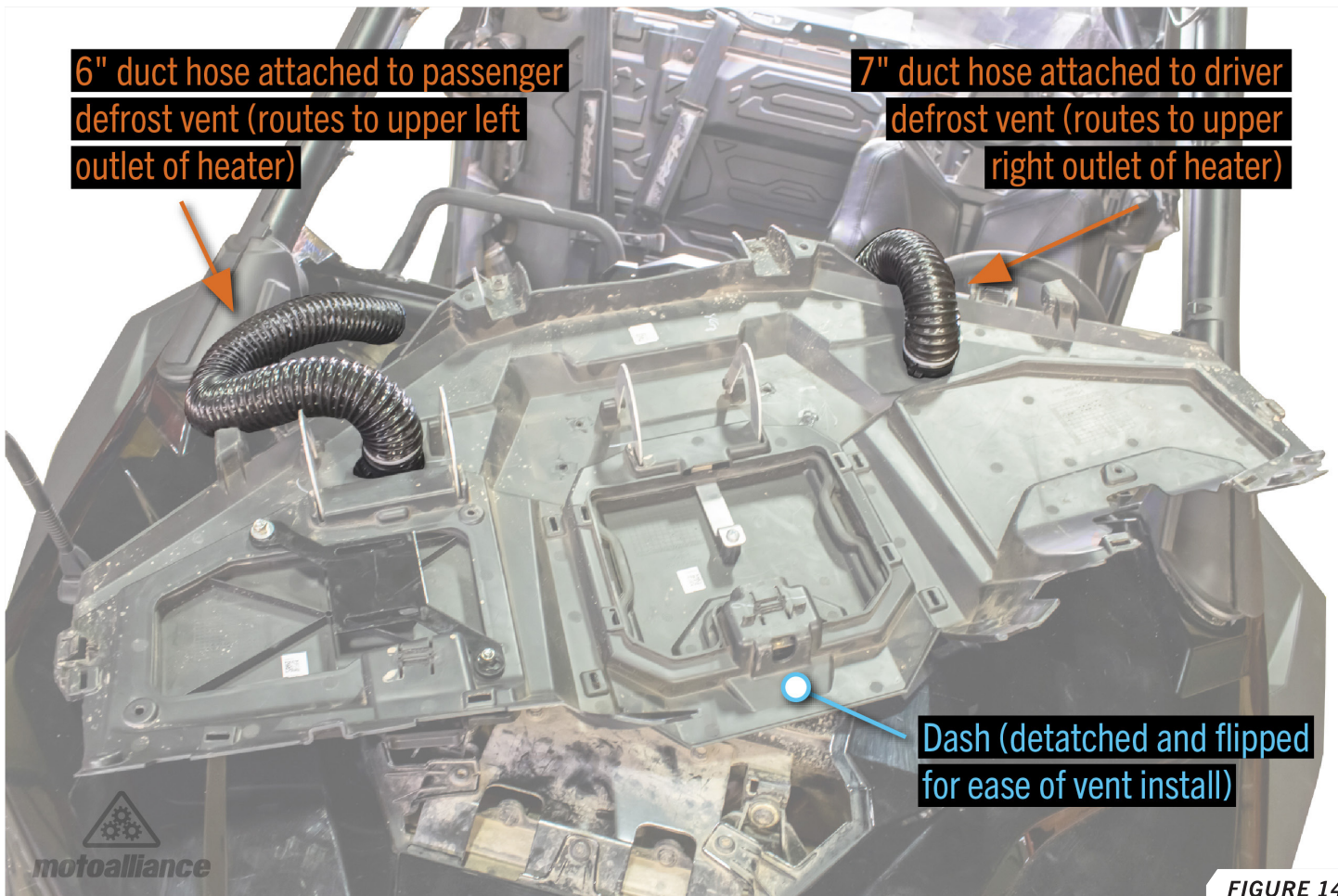

48. Clean any burs out of the holes and insert the two 50mm vents.
49. Connect the 7" duct hose to the upper right side of the heater and secure with a zip tie.
50. Route this duct hose to the driver side defrost vent and secure with a zip tie. *FIGURE 14*
51. Connect the 6" duct hose to the upper left side of the heater and secure with a zip tie.
52. Route this duct hose to the passenger side defrost vent and secure with a zip tie. *FIGURE 14*

DEFROST DUCT HOSE ROUTING

53. Attach the heater unit to the bracket. Leave bolts loose to allow for adjustment in later steps. **FIGURE 15**

It is helpful for one person to hold the heater unit up to the bracket while another bolts the unit in.



FIGURE 15

BLEEDING THE COOLANT SYSTEM

Read entire section before proceeding

 Some amount of air will have made its way into the coolant system. The following bleeding procedure must be performed to eliminate the air and obtain heat. The following procedure is most easily accomplished with the help of a partner.

54. Fill radiator with coolant until radiator is full.
55. Open the shutoff valve.
56. Close the radiator cap and drive the machine around until heat comes through the vents or the machine's engine temperature goes above 200°F.
57. Turn off the machine and wait for it to cool down.
58. Open the radiator cap and add more coolant.

Look at owner's manual for manufacturer-approved coolant

59. Repeat the steps in this section until consistent heat is coming out of the vents and machine temperature gauge stays under 200°F.
60. Verify that no leaks have occurred and that the radiator fluid level is per the manufacturer's specifications.

FINISHING

61. Tighten bolts on the heater bracket.
62. Fit the dash panel to the machine.
63. Install the skid plate on the machine.
64. Install the dash panel and center panel on the machine.

If heater will not fit, loosen the bolts to let the heater move and check the orientation in step 44.

REPLACEMENT PARTS



Replacement parts can be ordered from motoalliance.com. Enter the associated SKU number into the search bar to find the product.

Item Description	SKU
2" Compressed Duct Hose	HT_2inch_Compressed
50mm Vent	HT_50mm_Louver
FIRESTORM Heater Motor	RPL_HT_CU_Fan_and_Motor
3-Position Switch	HT-FanSwitch
5/8" Radiator Hose	HT_RadiatorHose_20

Item Description	SKU
1" Aluminum Y	HT_1
1/2" Aluminum Y	HT_1/2
Plastic Shut-Off Valve	HT_Plastic_Shutoff_Valve
1/2" Plastic Shut-Off Valve	HT-Shutoff-Valve.5

Scan this QR code to see the full list of FIRESTORM replacement parts on motoalliance.com



Scan this QR code to get more tech help, watch troubleshooting videos, or submit a help form on motoalliance.com

